

## LIST OF LOADING PAMPHLETS—CLOSED CARS

*(Bracketed date indicates latest issue)*

- | No. | TITLE   |
|-----|---|
| 1   | Automobiles—Motor Vehicles Shipped in Auto Loader Cars (April, 1949)  |
| 2   | Automobiles—Motor Vehicles Shipped L.C.L. or Carload in Other than Auto Loader Cars (April, 1949)                                       |
| 3   | Bags—Commodities In—Flour and Other Grain Products, Sugar and Kindred Commodities, Rice, Salt, Coffee, Beans, Peanuts, etc. (Feb. 1945) |
| 4   | Barrels, Drums or Kegs (Jan. 1948)  |
| 5   | Batteries—Storage (Dec. 1941)   |
| 6   | Brick and Hollow Building Tile (Dec. 1941)  |
| 7   | Brick—Hot Top (Jan. 1942)   |
| 8   | Butter in Tubs in Refrigerator Cars (Dec. 1941)   |
| 9   | Cable on Reels and Wire Commodities (Oct. 1948)   |
| 10  | Car Doors—Battering as Protection Against Damage by Weather, Cinders, etc. (Dec. 1941)  |
| 11  | Car Wheels—Loose (Dec. 1941)  |
| 12  | Cylinders—Empty, With or Without Caps (June 1945)   |
| 13  | Fibreboard Containers (Solid or Corrugated)—Commodities in (Sept. 1943)   |
| 14  | Freight—Loading, Bracing and Blocking Of (May 1947)   |
| 15  | Furniture—Carload (Aug. 1947)   |
| 16  | Furniture—Less-Carload (Nov. 1941)  |
| 17  | Grain and Grain Products in Fibreboard Containers and Sacks (Jan. 1945)   |
| 18  | Ink and Like Commodities in Six-Gallon Steel Pails and Similar Containers (Dec. 1941)   |
| 19  | Livestock—Loading and Handling (Jan. 1942)  |
| 20  | Lumber (Dressed) and Mill Work (Dec. 1941)  |
| 21  | Machinery (July 1945)   |
| 22  | Marble in Slabs—"A" Frame Method (Dec. 1941)  |
| 23  | Sheet Steel, Tin Plate and Other Steel Products (Nov. 1942)   |
| 24  | Mixed Loads of Commodities in Wooden Cases, Cartons, Drums, Barrels or Pails (Aug. 1945)  |
| 25  | Paper and Similar Commodities on Skids (April 1945)   |
| 26  | Gypsum Plasterboard, Wallboard, Sheathing, Lath and Plaster (April 1950)  |
| 27  | Projectiles, Bombs and Cartridge Cases (Empty) (Nov. 1943)  |
| 28  | Radiators—Cast Iron (Jan. 1942)   |
| 29  | Refrigerators—Mechanical (Dec. 1941)  |
| 30  | Roofing Materials—Prepared (Dec. 1941)  |
| 31  | Soda Ash (Aug. 1945)  |
| 32  | Stones—Pulp Grinder (Dec. 1941)   |
| 33  | Stoves and Ranges (July 1943)   |
| 34  | Tank Cars—Transporting Non-Dangerous Commodities (Aug. 1941)  |
| 35  | Untreated Cross Ties (May 1942)   |
| 36  | Bulk Grain (July 1950)  |
| 37  | Pig Lead, Copper Bars and Similar Commodities (July 1944)   |
| 38  | Unsaturated Roofing Felt and Pulpboard Paper (March 1945)   |
| 39  | Newsprint (Aug. 1945)   |
| 40  | Vitrified Clay Sewer Pipe (Jan. 1947)   |
| 41  | Dictionary of Standard Terms (June 1947)  |
| 42  | Rolled and Plate Glass (Not Bent) (Aug. 1949)   |

For Copies Address

SECRETARY

FREIGHT LOADING AND CONTAINER SECTION

59 EAST VAN BUREN STREET  
CHICAGO 5, ILLINOIS

## Rules Regulating The Safe Loading of Bulk Grain in Closed Cars and Protection of Equipment

 SIGNODE STEEL STRAPPING CO.  
 2600 N. WESTERN AVENUE  
 CHICAGO 47, ILLINOIS

ISSUED APRIL, 1925

REVISED JULY, 1950

Prepared and Published by

### Association of American Railroads

Operations and Maintenance Department

Operating-Transportation Division

FREIGHT LOADING AND CONTAINER SECTION

59 EAST VAN BUREN STREET  
CHICAGO 5, ILLINOIS

Printed in U. S. A.

**RULES REGULATING THE SAFE LOADING  
OF  
BULK GRAIN IN CLOSED CARS  
AND  
PROTECTION OF EQUIPMENT**

**GENERAL RULES**

*The "General Rules," as contained in Circular No. 42, or supplements thereto, issued by the Operating-Transportation Division, Association of American Railroads, which have been formulated for the purpose of providing safe methods of loading in closed cars, must be observed.*

---

The Grain Door Detailed in Paragraphs D-1—D-10, Inclusive, and Illustrations Nos. 12-22, Inclusive, are Patented.

---

**A—SELECTION AND PREPARATION OF CARS**

**A-1**—Inspect car thoroughly outside and inside to determine if suitable for transportation of bulk grain and can be made grain tight by the use of cooperage materials.

**A-2**—Do not load cars with shattered or broken doorposts, floors or linings showing the presence of oil, creosote, fertilizer, manure, or other substance likely to damage the grain, or with other defects which render it unsuitable.

**Sheathing Boards**

**A-3**—When sheathing boards are spread at corner post or doorposts—reject the car.

**Clean Car Before Coopering**

**A-4**—The residue or refuse from previous loading should be removed and the car swept clean.

**Inside Linings**

**A-5**—Cover broken and defective lining pieces with boards. Do not use paper or grain doors for this purpose. (See Illustration No. 1.)

**A-6**—If grain vents at floor are obstructed they should be reopened. Do not remove any permanent lining.

**A-7**—Look for cracks or defects in car floor and cooper effectively:

- (a) At ends of floor boards. (See Illustration No. 2.)
- (b) At ends of car between last board and end lining. (See Illustration No. 2.)
- (c) Between floor boards. Calk or cover with cooping paper. If separations are too wide to be calked, reject car.
- (d) Cover defects and holes in car floor with thin metal pieces, taking extreme care that all edges are secured with small nails. (See Illustration No. 1.)

**A-8**—End Doors

- (a) Fasten end doors by locking or cleating on inside.
- (b) Pad surfaces around end door openings before boarding the openings. (See Illustration No. 1.)
- (c) Completely close door openings with boards and cover with calking paper. (See Illustration No. 1.)

## B—PREPARATION OF DOORPOSTS AND BOTTOM GRAIN DOORS

**B-1**—Apply twisted calking paper on each doorpost to the height the car is to be coopered. Calking paper should also be tacked to the bottom edge of the first grain door. This will insure against leakage under the door should the frame of the car or grain door edge be uneven. (See Illustrations Nos. 3 and 4.)

## C—APPLICATION OF WOOD GRAIN DOORS

**C-1**—Select good sound doors free from protruding nails. The grain doors must be fabricated in accord with the following specifications:

Doors shall be 7\* feet long, 20\* inches and 10\* inches wide, made of two courses of full length lumber laid lengthwise and close edge to edge, with one 6 inch batten at each end on one side ½ inch shorter than width of the door, the ½ inch divided at each end of batten. Thickness of lumber to be uniform in each door, not less than 25/32 inch nor more than 1 inch, in any widths of 4 inches or more.

*\*A length of 7 feet 6 inches instead of 7 feet, and widths of 18" and 8" instead of widths of 20" and 10" are acceptable as alternate dimensions.*

**C-2**—The bottom door (which has had calking paper applied on lower edge) should now be firmly placed against the doorpost and car floor, securing to doorpost with two twelve-penny nails at each end. If the doorpost has excessive splits, holes, etc., nail only into sound wood. **UNDER NO CIRCUMSTANCES USE SPIKES IN NAILING GRAIN DOORS.**

**C-3**—Succeeding courses of grain doors should be applied tightly against lower door and doorposts. Fill cracks at each end of second,

third, and fourth door with calking paper so that reinforcing boards or doors will cover same, holding paper in place. (See Illustration No. 5.)

## Reinforcing Grain Doors

**C-4**—On loads of less than 80,000 pounds, the joints between the 20" doors can be reinforced by placing a 1" x 8" board or 20" grain door in a horizontal position overlapping the joint, and should be nailed to the door over the joint with three nails, not less than 8d size, one at each end and one in the center. Do not nail these reinforcing boards or doors to the door below the joint as it increases the difficulty of releasing the barricade at destination without damage to the doors. (See Illustration No. 6.)

**C-5**—On loads of 80,000 lbs, and over, the joint between the first and second, and second and third grain doors should be reinforced with a 20" door, nailing same to the door above the joint, as shown in Illustration No. 7. The remaining joints between doors can be reinforced with 1" x 6" or 1" x 8" boards in the manner described in Paragraph C-4.

**C-6**—Illustration No. 7 shows application of grain doors, reinforcing doors and reinforcing boards on cars where door sills are lower than car floor. Where door sills are level with or higher than car floor, the lower 10" reinforcing doors may be eliminated.

**C-7**—As an added stiffener to the barricade, an upright board 1" x 6" can be applied on the OUTSIDE of the grain doors and nailed securely to each door but do not clinch the nails. The upright can be held in position by nailing a 1" x 4" wood cleat to the floor of the car at the bottom of the upright. The cleat should be placed about ½" away from the upright so that when the pressure of the load against the barricade causes it to bulge, the upright will spring outward to a snug fit with the cleat. The use of this upright, where practicable, is recommended as it makes a single unit of the entire barricade and strengthens it considerably and prevents excessive bulging. (See Illustration No. 8.)

## D—APPLICATION OF STEEL STRAP-REINFORCED GRAIN DOORS (PATENTED)

(See Illustrations Nos. 12-22, Inclusive)

The following instructions should be observed to obtain maximum efficiency when applying barricade.

**D-1**—First Step: Place a 1" x 6" undressed board, length to span doorway, across each doorway and nail to bottom of each doorpost with two 12d common nails. This board is shown in Illustration No. 13. The board serves as a fulcrum into which the point of a pry bar may be jabbed when opening car doors for inspection while en route or at destination. A 6"—12" length of calking paper should be tacked to

each doorpost immediately above Bottom Protecting Board to seal crevice caused by fold when grain door is placed over this board.

**D-2—Second Step:** Place a 1" x 6" Top Protecting Board, length to span doorway on floor of car. Any other dimension board which will support the weight of a man may be substituted for a 1" x 6" board. This board enables workmen and inspectors to enter and leave the car and furnishes support for loading spouts. Place the folded Grain Door on the floor adjacent to the Protecting Board with Top of Door Down as shown in Illustration No. 13.

**D-3—Third Step:** Open top fold of Grain Door and place in position on the Top Protecting Board, see Illustration No. 14. Drive two nails through holes in top strap at each side of door with one strap hole space between the nails.

**D-4—Fourth Step:** Turn the Grain Door over and start two 12d nails into righthand end of Top Protecting Board. (See Illustration No. 15.)

**D-5—Fifth Step:** Place assembled Grain Door with Top Protecting Board centered in position across car doorway as shown in Illustration No. 16. Hold the Grain Door firmly against Bottom Protecting Board with one foot; Grain Door must be taut. Nail right end of Top Protecting Board to car doorpost. Repeat this operation at opposite end of Grain Door, securing the Top Protecting Board at left hand end with two 12d nails.

**D-6—Sixth Step:** Nail each strap on one side of the Grain Door by driving a minimum of two 1¼" or longer 10¼ gauge, (8d wire size) double-head nails straight into the car doorposts. The two double-head nails must be spaced at least one strap hole apart, see Illustration No. 18. Complete the application of the Grain Door at the other side by tension nailing the first nail driven through each strap into the car doorposts, see Illustration No. 17. Tension nailing is obtained by tilting the nail towards the opposite doorpost at start of nailing, for purpose of drawing strap tight as nail is being driven. It is important that the second nail at the end of each strap at this side of the Grain Door be driven straight into the car doorpost. (Inside view of installed Grain Door is shown in Illustration No. 19.)

**D-7—Seventh Step:** Nail the floor flap to the car floor with not less than four nails spaced about 20" apart and driven through the floor flap strap. (See Illustration No. 19.)

**D-8—Outside view of installed Grain Door is shown in Illustration No. 20.**

**D-9 — OPENING STEEL STRAP-REINFORCED GRAIN DOORS:** The Grain Door may be ruptured by using a hatchet to cut the straps near the doorposts. See Illustration No. 21. Nails in floor flaps should be removed with a pry bar or claw hammer.

**D-10—SAFETY MEASURE:** After the car has been emptied the ends of steel straps remaining on the doorposts must be removed by

drawing the double-headed nails with a claw hammer or pry bar. (See Illustration No. 22.) Allowing these straps to remain on doorposts is a constant source of possible injury to elevator workmen and trainmen. If these double-headed nails and straps are not removed other freight loaded into these cars might readily be damaged.

## E—HEIGHT OF GRAIN DOOR PROTECTION

**E-1—Grain doors should be applied higher than the grain in the car will level, allowing a minimum of six inches between top of load and top of grain doors.**

## F—TRIMMING GRAIN IN CARS

**F-1—To prevent spillage over grain doors by shifting of the load during transit and to insure proper distribution of weight in the car, the loader of bulk grain is required to trim (level) the grain and determine whether height of grain requires additional boards.**

## G—INSPECT CAR AFTER LOADING

**G-1—After car is loaded, it should again be inspected to see that it is grain tight and that grain doors have been properly installed and sufficiently braced. If inspection develops any defects in car or in grain doors, which cannot be repaired under load, car should not be allowed to go forward.**

## H—BULKHEADS

**H-1—When bulkheads are used they must be furnished by the shipper at his expense; they should be constructed of ship-lap or square edge lumber not less than one inch in thickness applied not closer than ten inches to the doorpost. Nails must not penetrate through the sides or floor of the car. The vertical and diagonal braces provide the main support to the bulkhead, making it unnecessary for the use of bracing at the sides of the car in excess of that shown in Illustration No. 9.**

## I—REPLACE TOP BOARD AFTER SAMPLING

**I-1—When it is necessary to remove top board for facility of entry by sampler from a grain inspection department, the board must be replaced prior to closing the car door in order to prevent loss of grain.**

## J—METHODS FOR RELEASING GRAIN FROM CARS (For Release of Grain from Cars Coopered with Steel Strap Reinforced Doors See Paragraph D-9.)

**J-1—To readily release grain from cars and to prevent damage to wood grain doors, a properly shaped bar should be used as shown in Illustrations Nos. 10 and 11. Apply the leverage to best advantage**

following the steps outlined below: (See Illustrations Nos. 23, 24 and 25.)

- (a) Remove upright reinforcing cleats, and floor cleats where used.
- (b) Remove the top door first, then the next door from the top, and so on down.
- (c) Loosen Both Ends of each Grain Door; starting at the top. Before attempting to pry one end of any grain door upward, be sure to loosen thoroughly both ends of the door from the doorposts. This loosening of a door from both doorposts, before attempting to pry the door upward is of the utmost importance to facilitate the removal of each door.

### K—PROTECTION OF EQUIPMENT

#### Do Not Mutilate Car Doors or Sheathing of Cars

**K-1**—Do not jab the point of a crowbar into the doors or outside sheathing of cars. Many cars have to be sent to repair yards and rip tracks because of such mutilation.

#### PROTECTION OF GRAIN DOORS.

**K-2**—Shippers or consignees must not damage, destroy, appropriate or use a carrier's wooden grain doors, grain door lumber or other cooperage material for any purpose other than for which intended without specific permission from the carrier.

### L—SWEEP EACH CAR CLEAN

**L-1**—The unloader of bulk grain is required to unload completely and to sweep the car clean.

### PREPARATION OF CARS

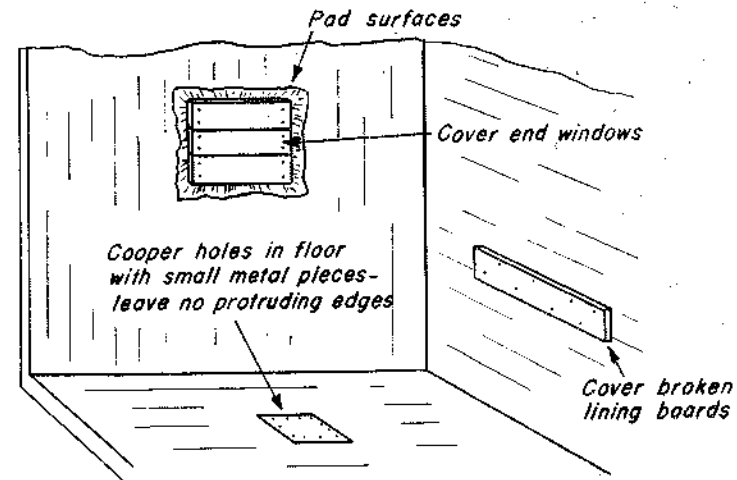

ILLUS. NO. 1

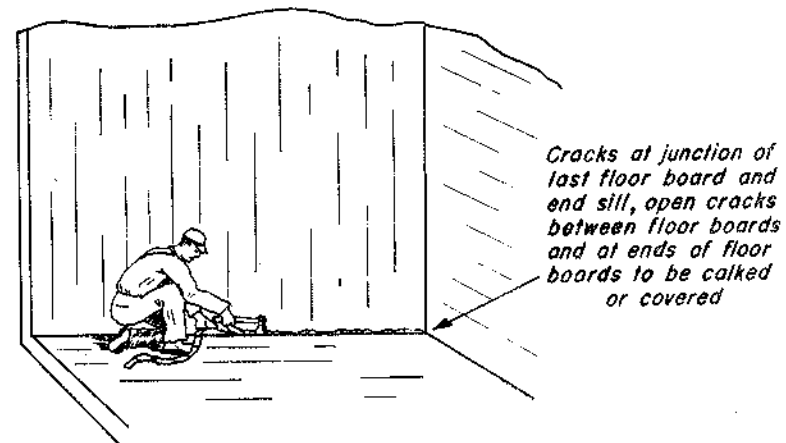

ILLUS. NO. 2

## APPLICATION OF GALKING PAPER

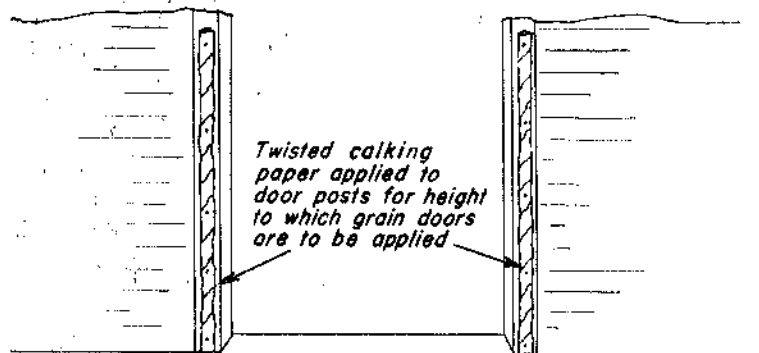

ILLUS. NO. 3

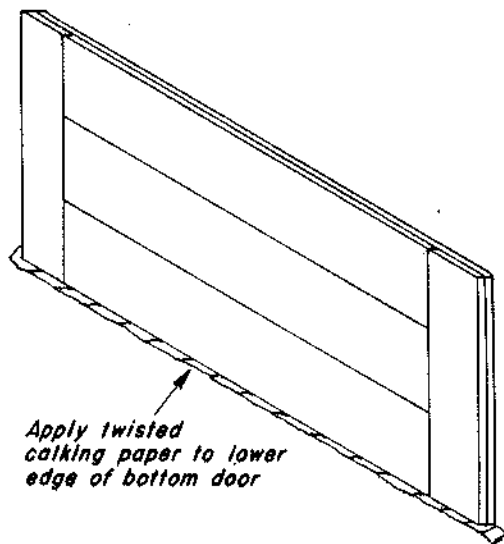

ILLUS. NO. 4

## APPLICATION OF GRAIN DOORS

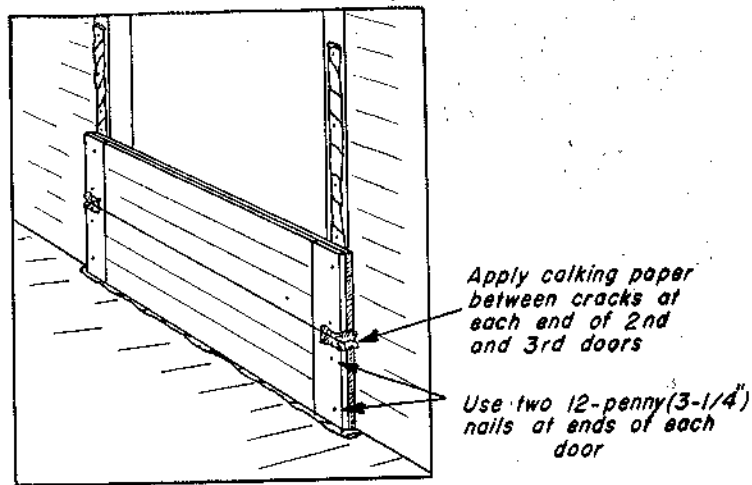

ILLUS. NO. 5

Grain Door  
Reinforcement - Inside  
(Loads Under  
80,000 Lbs.)

Secure each reinforcement board in place with one 8-penny (2-1/2") nail at each end and one in the center near top edge of board

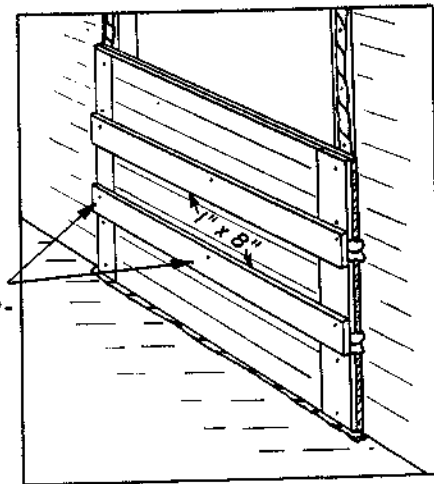

ILLUS. NO. 6.

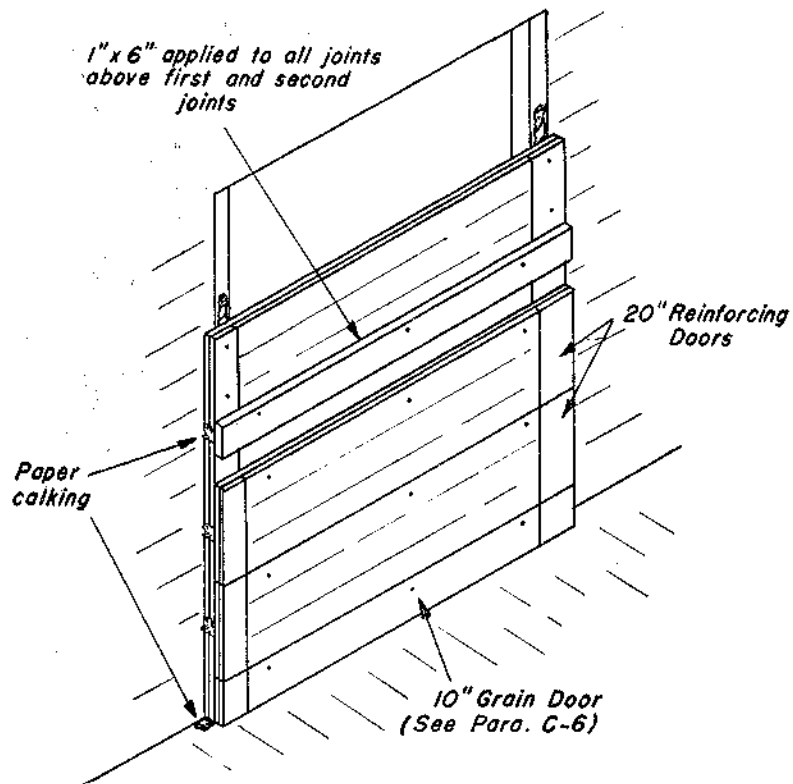

ILLUS. NO. 7

**GRAIN DOOR REINFORCEMENT-INSIDE**  
(Loads over 80,000 Lbs)

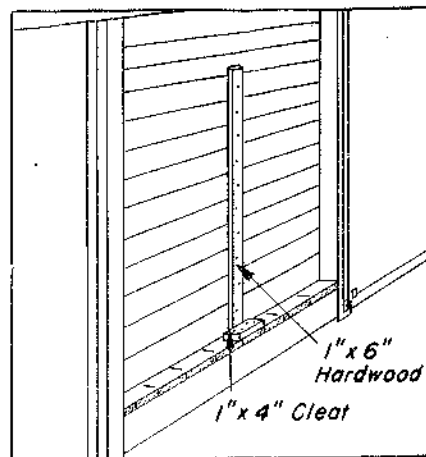

**Grain Door Reinforcement-Outside**

Provide 1/2" clearance between cleat and 1" x 6" upright to allow for bowing tendency of doors under pressure of the load

ILLUS. NO. 8.

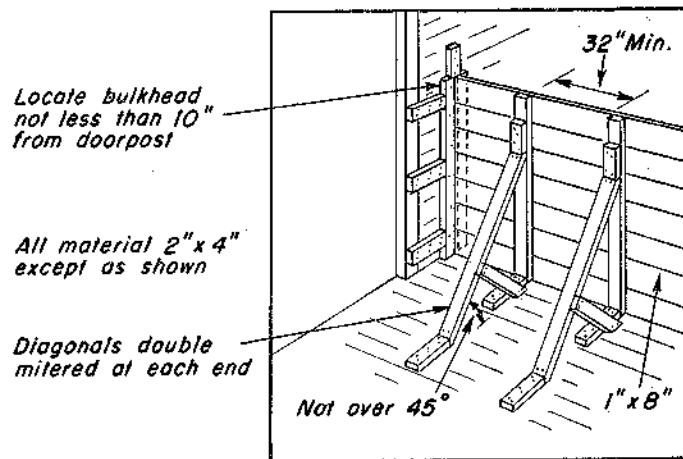

ILLUS. NO. 9

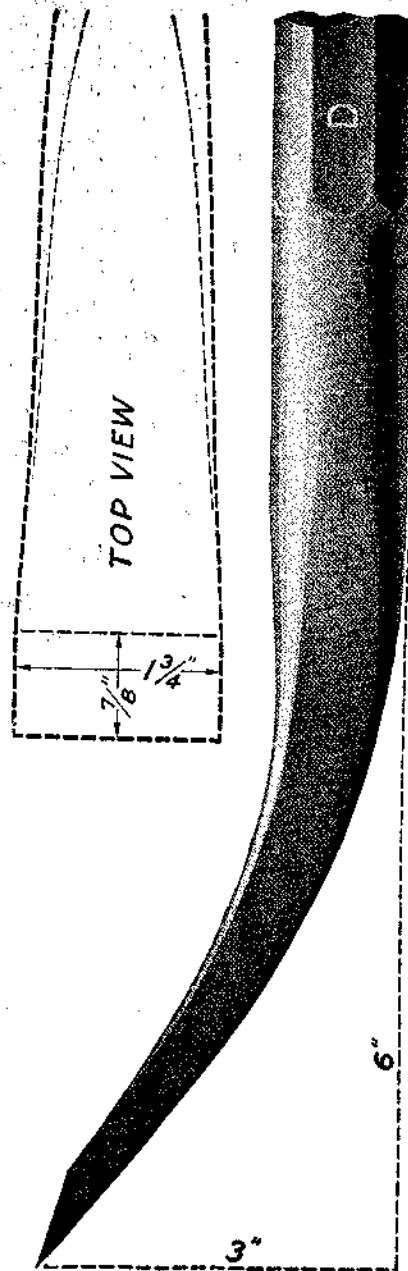

Illustration No. 10

Bar "D"—For releasing bulk grain from cars.

Metal—Octagon tool steel.  
Diameter— $1\frac{1}{4}$  inches.

Length—4 ft., 4 inches. The length of the bar may be modified, if need be, to fit conditions, due to lack of sufficient space at any unloading hopper.

Weight— $17\frac{1}{2}$  lbs.

Screen Guard—Guard (preferably at end), of sufficient size to prevent bar from passing between grate rods (screen), over grain unloading hoppers.

Foot—Arc (or throw), 3 inches.

Fulcrum—Variable from point of blade to extreme heel which is 6 inches.

Blade—Width  $1\frac{3}{4}$  to 2 inches.

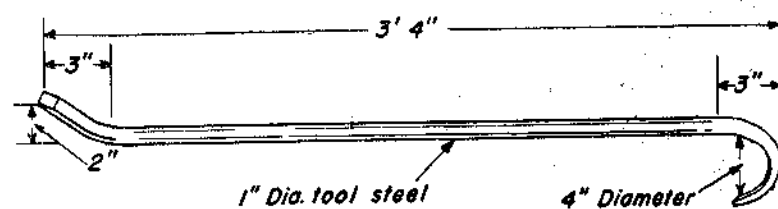

ILLUS. NO. 11  
BAR FOR RELEASING GRAIN DOORS



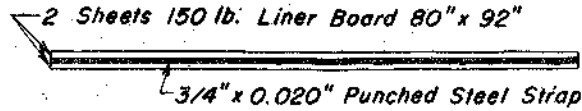

SECTION A-A

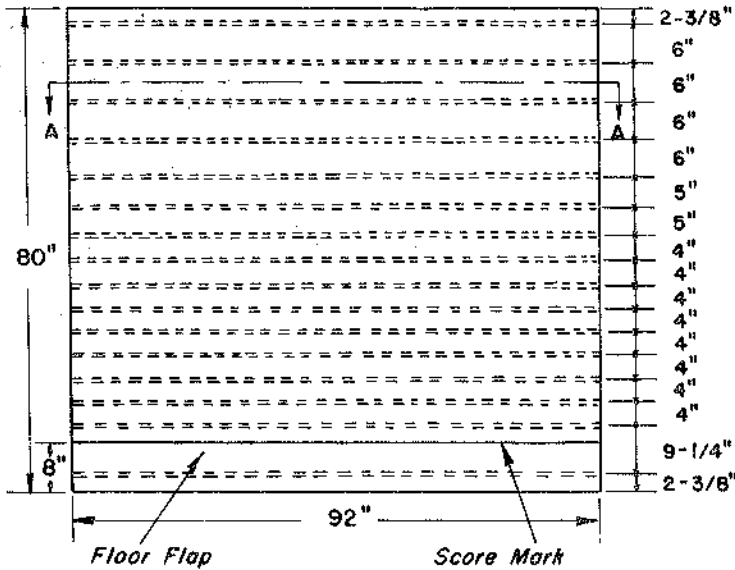

SIDE VIEW

ILLUS. NO. 12

STEEL STRAP-REINFORCED GRAIN DOOR  
 (PATENTED)  
 (SHOWING SPACING OF STEEL STRAP)

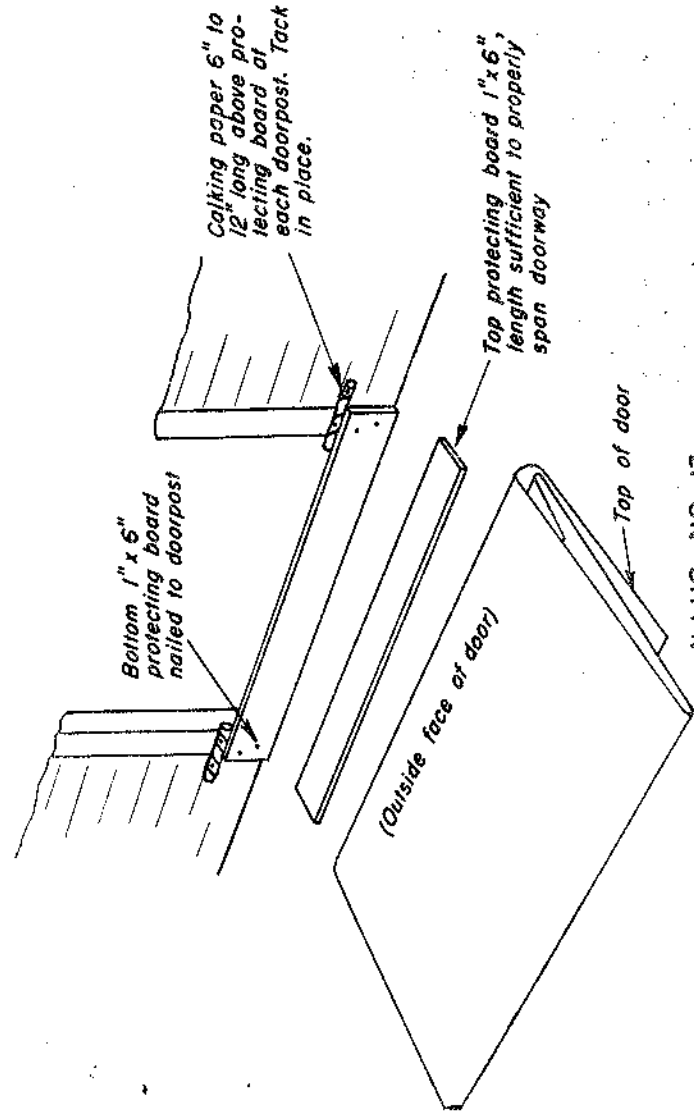

ILLUS. NO. 13  
 (FIRST AND SECOND STEPS)

APPLICATION OF BOTTOM PROTECTING BOARD AND POSITIONING OF STEEL STRAP-REINFORCED GRAIN DOOR PRIOR TO NAILING TO TOP PROTECTING BOARD

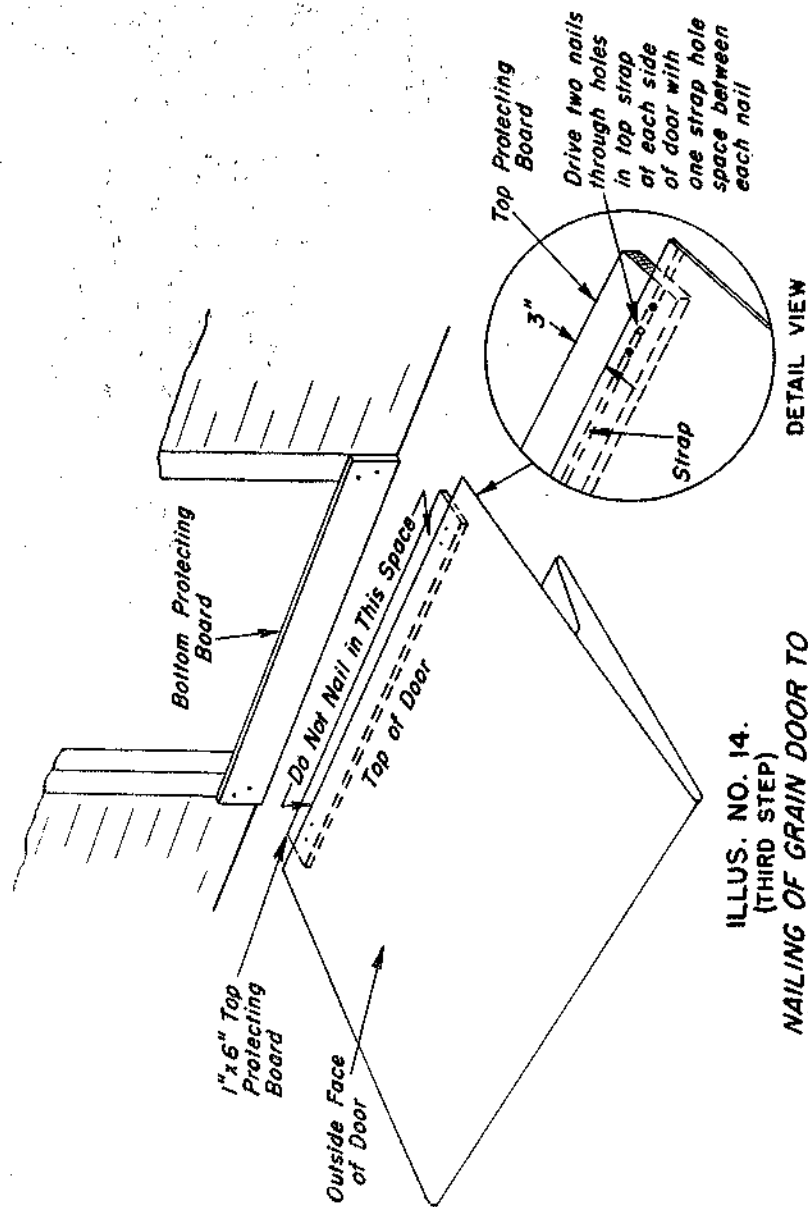

ILLUS. NO. 14.  
(THIRD STEP)  
NAILING OF GRAIN DOOR TO  
TOP PROTECTING BOARD

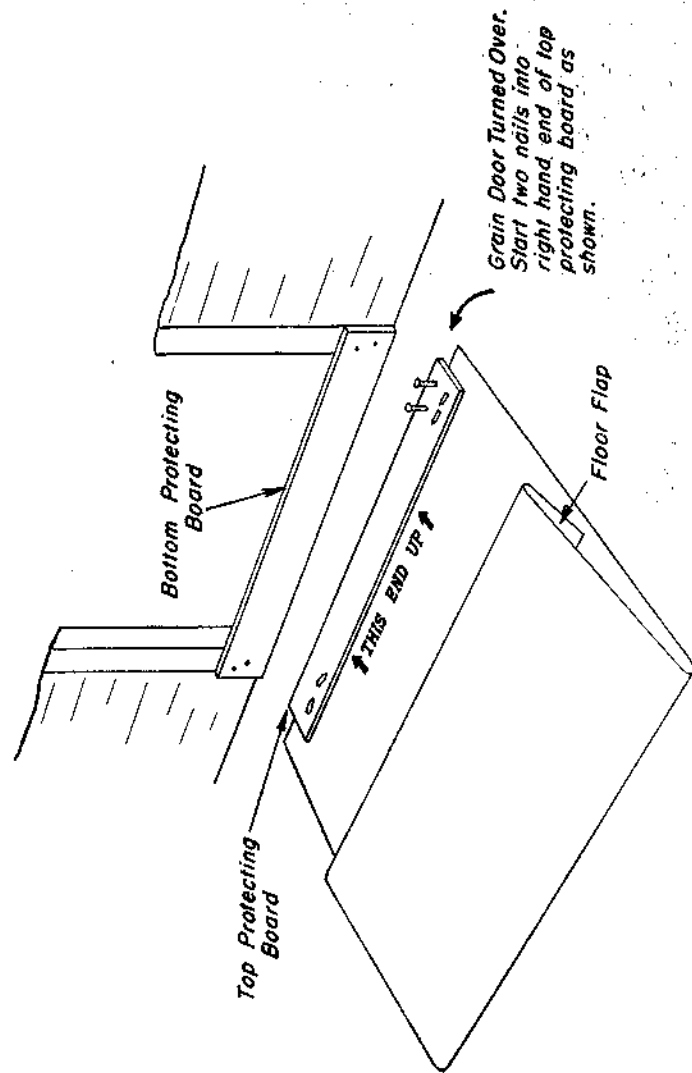

ILLUS. NO. 15  
(FOURTH STEP)  
STEEL STRAP-REINFORCED GRAIN DOOR READY  
FOR APPLICATION TO CAR DOORPOSTS

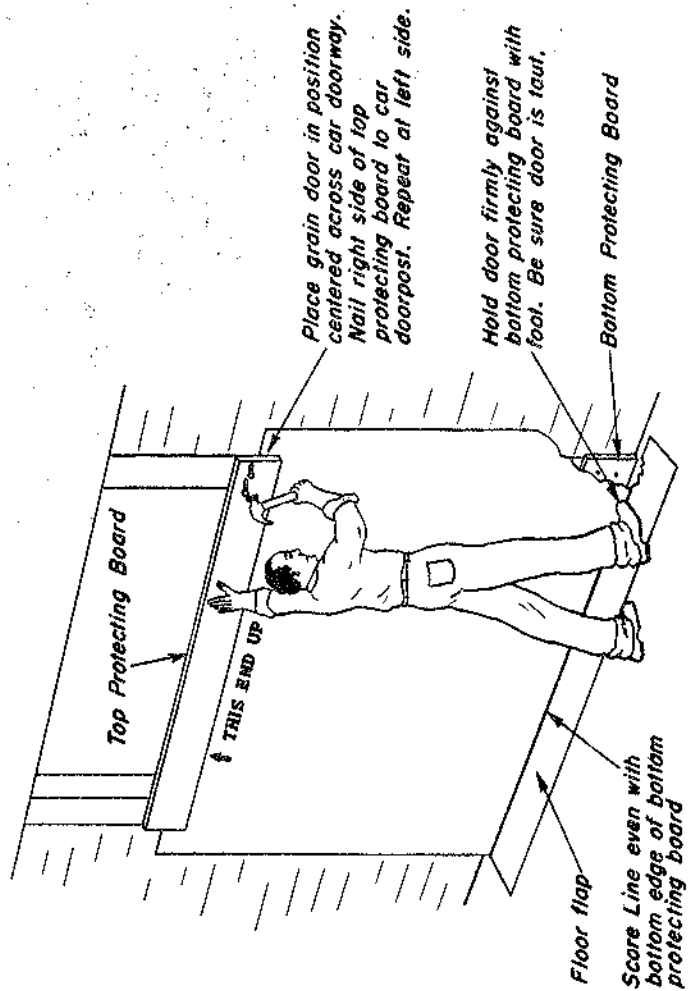

ILLUS. NO. 16.  
(FIFTH STEP)  
HANGING GRAIN DOOR IN POSITION

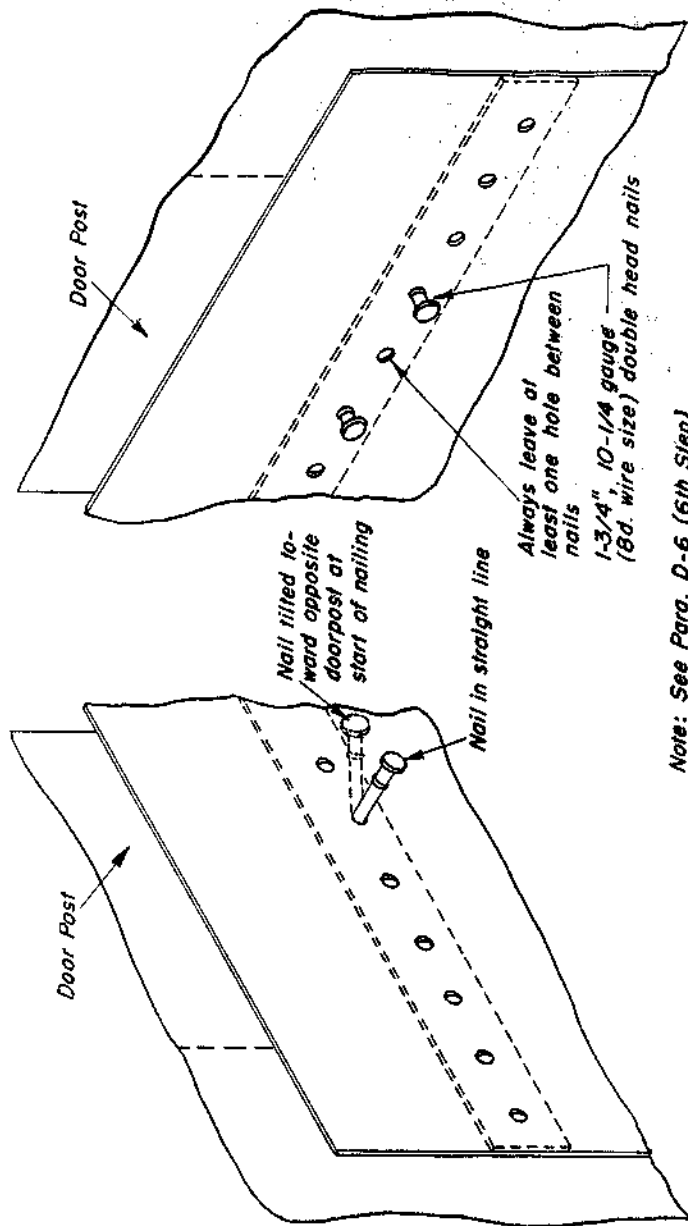

Note: See Para. D-6 (6th Step)

ILLUS. NO. 18.

ILLUS. NO. 17

TENSION NAILING PROCEDURE

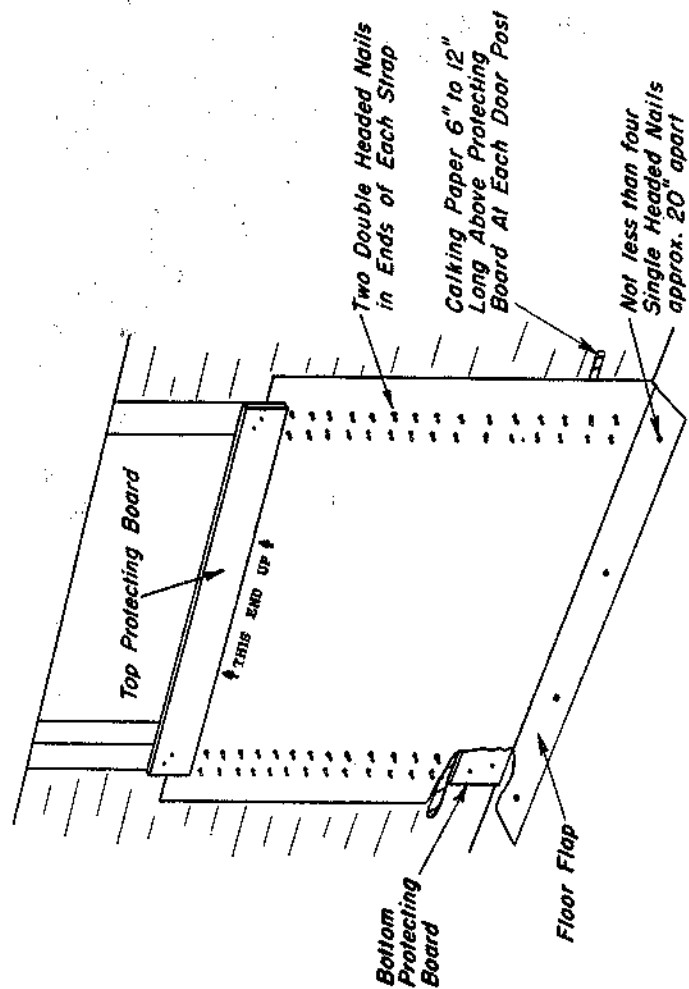

ILLUS. NO. 19  
(SIXTH AND SEVENTH STEPS)  
INSIDE VIEW OF INSTALLED STEEL STRAP-REINFORCED  
GRAIN DOOR

APPLICATION OF STEEL STRAP-REINFORCED  
PAPER DOORS

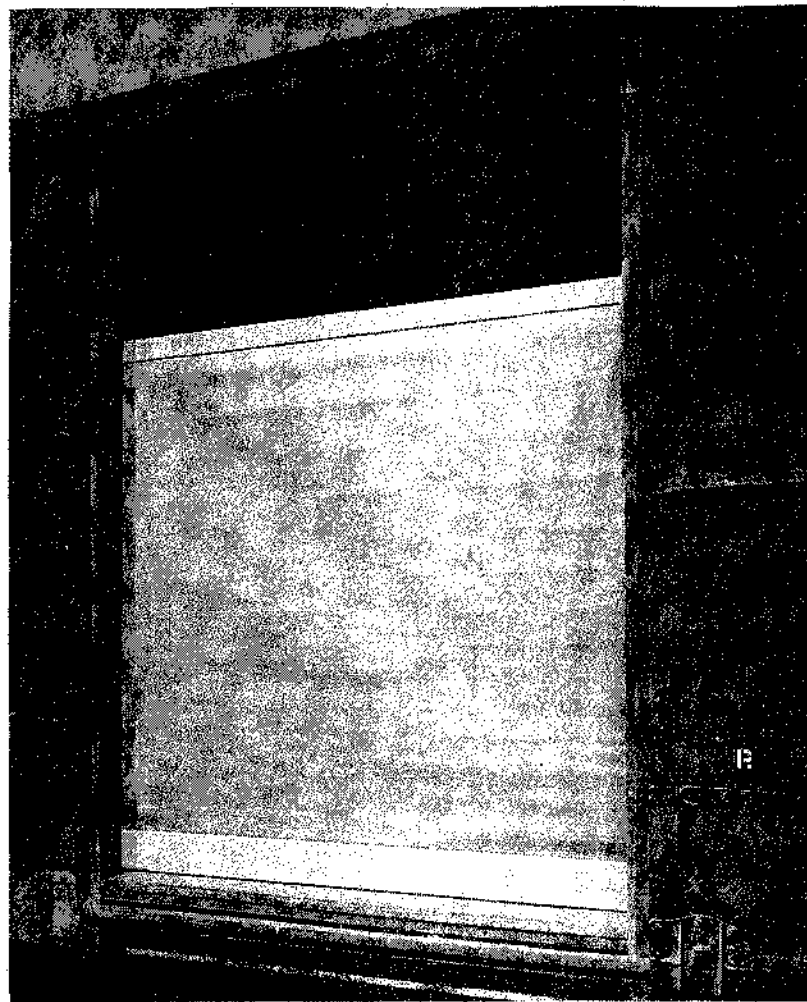
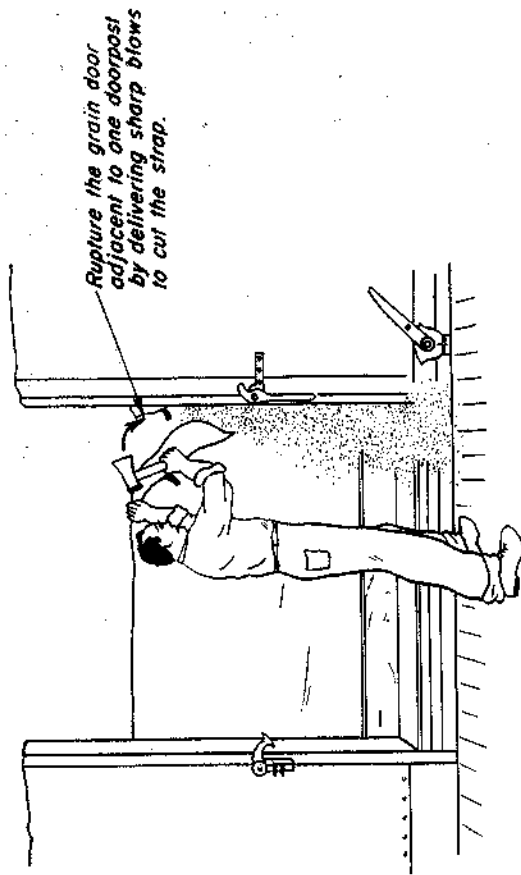
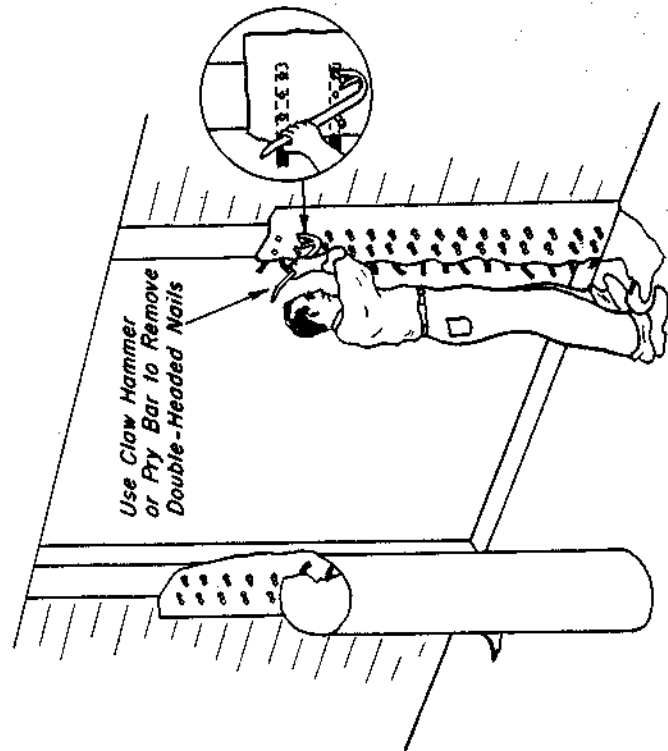

Illustration No. 20  
OUTSIDE VIEW OF INSTALLED GRAIN DOOR  
(See Section D)



ILLUS. NO. 21.

## OPENING STEEL STRAP-REINFORCED GRAIN DOOR



ILLUS. NO. 22

AFTER UNLOADING, REMNANTS OF GRAIN DOOR MUST BE REMOVED TO PREVENT DANGLING STRAPS, FROM INJURING ELEVATOR WORKMEN AND TRAINMEN AS WELL AS DAMAGE TO OTHER FREIGHT.

## RELEASING GRAIN FROM CARS

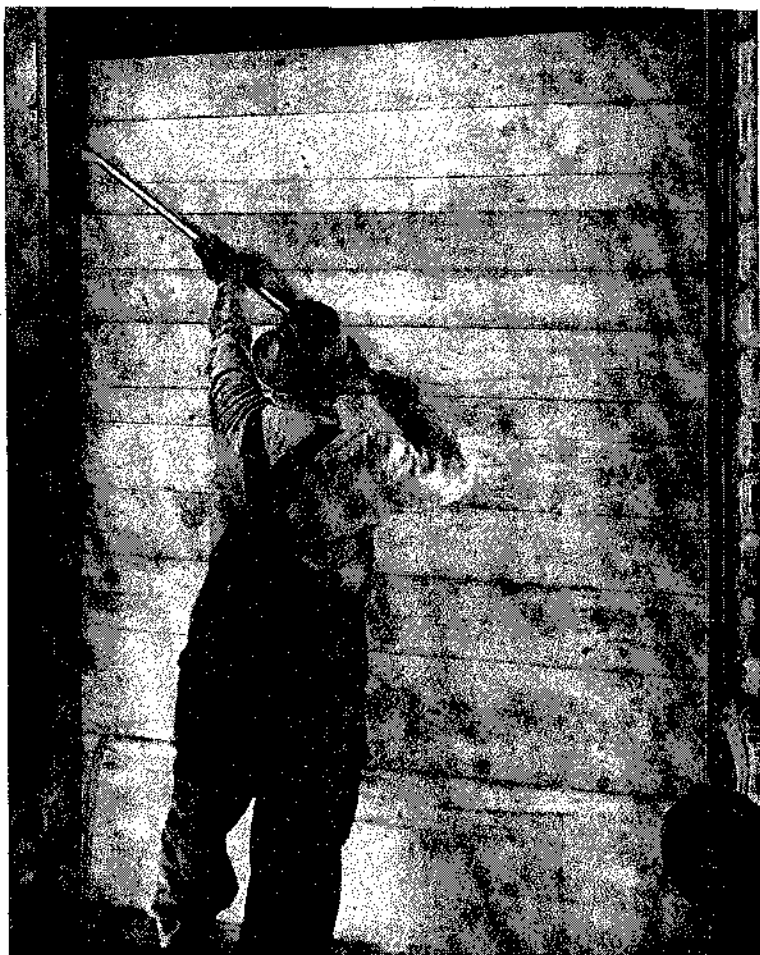

Illustration No. 23  
 ENDS MUST BE WELL LOOSENED FROM DOORPOSTS  
 BEFORE PRYING ANY DOOR UPWARD

## RELEASING GRAIN FROM CARS



Illustration No. 24  
 AFTER ENDS ARE THOROUGHLY LOOSENED, PRY DOOR  
 UPWARD, FIRST ONE END, THEN OTHER END

## RELEASING GRAIN FROM CARS



Illustration No. 25  
SILLS PROVIDE EXCELLENT FOOTING FOR RAISING LAST  
DOOR; BUT FIRST PRY BOTH ENDS OF DOOR LOOSE  
FROM POSTS

---

---

Approved by

GENERAL COMMITTEE  
OPERATING-TRANSPORTATION  
DIVISION

---

---